



NFK GLAZING & INDUSTRIAL SUPPLIES

Professional Products for the Glass & Glazing industry



BILOBA UNICA

HYDRAULIC DOOR CLOSER

indoor / outdoor applications

We Build the Invisible



NFK Glazing
& Industrial Supplies

www.nfk.com.au

 28 Devlan Street,
Mansfield, QLD 4122

 07 3343 3377

 sales@nfk.com.au

 42 Tacoma Circuit,
Canning Vale, WA 6155

 08 9455 3866

 wasales@nfk.com.au



- This unique product, designed and manufactured in Italy
- A miniaturised hydraulic door closer, concealed within a corner patch fitting 56mm high x167mm long
- Capable of supporting 100kg of glass doors from 8mm to 13.53mm thick
- Adjustable closing and latching speeds
- Stops at 0°, +90° and -90°
- The closing automatism kicks in within the 70°-80° range. The closing is soft for the first 20° and becomes speed-adjustable from 60° up to complete closing.
- Suitable for indoor/outdoor applications

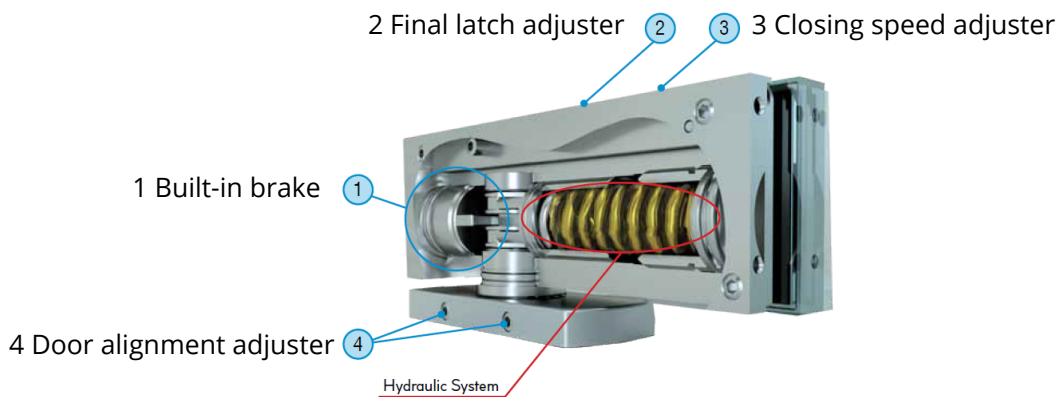
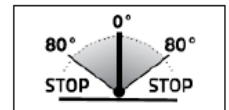
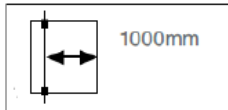

A SINGLE hinge can be used to support heavy doors without having to change the closing mechanism, which remains automatic. The pivot variant can be mounted on very large doors, providing excellent stability, safety and minimum space.

STANDARD APPLICATION

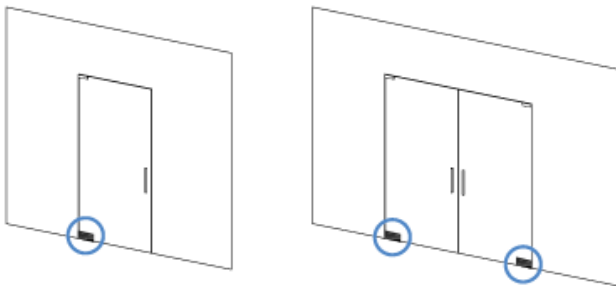

PIVOT APPLICATION

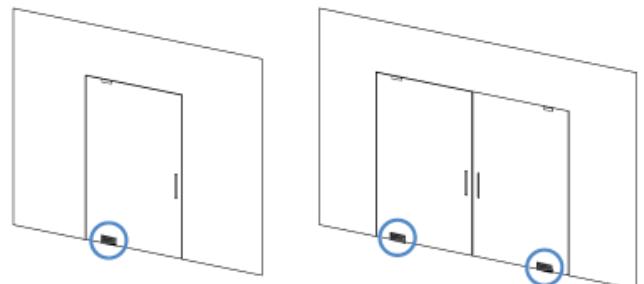

NFK Glazing
& Industrial Supplies

www.nfk.com.au

28 Devlan Street,
Mansfield, QLD 4122

07 3343 3377

sales@nfk.com.au

42 Tacoma Circuit,
Canning Vale, WA 6155

08 9455 3866

wasales@nfk.com.au



BILOBA UNICA KITS

Set #	Mounting	Type	Finish	Components	Code
#1 Kit	Frameless glass door / wall	Hold-Open	Satin	Top Corner Patch, Top Pivot transom, Biloba Unica bottom patch	19-SH/0781.77
#1 Kit	Frameless glass door / wall	Hold-Open	Polished	Top Corner Patch, Top Pivot transom, Biloba Unica bottom patch	19-SH/0781.99
#1 Kit	Frameless glass door / wall	Non-Hold-Open	Satin	Top Corner Patch, Top Pivot transom, Biloba Unica bottom patch	19-SH/078NHO.77
#1 Kit	Frameless glass door / wall	Non-Hold-Open	Polished	Top Corner Patch, Top Pivot transom, Biloba Unica bottom patch	19-SH/078NHO.99
#2 Kit	Frameless glass door / High-Lite	Hold-Open	Satin	Top Corner Patch, High-Lite Pivot Patch, Biloba Unica bottom patch	19-SH/0782.77
#2 Kit	Frameless glass door / High-Lite	Hold-Open	Polished	Top Corner Patch, High-Lite Pivot Patch, Biloba Unica bottom patch	19-SH/0782.99
#3 Kit	Frameless glass door / High-Lite/ Side-Lite	Hold-Open	Satin	Top Corner Patch, Corner link Patch with Pivot, Biloba Unica bottom patch	19-SH/0783.77
#3 Kit	Frameless glass door / High-Lite/ Side-Lite	Hold-Open	Polished	Top Corner Patch, Corner link Patch with Pivot, Biloba Unica bottom patch	19-SH/0783.99

Kit #1



page 3-4

Kit #2

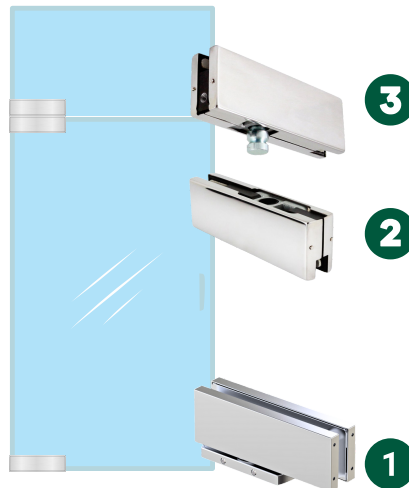

page 5-6

Kit #3



page 7-8



GLASS CUTOUT for Kit #1



1

Biloba Unica hydraulic door closer



2

Top Corner Patch



3

Top Pivot transom

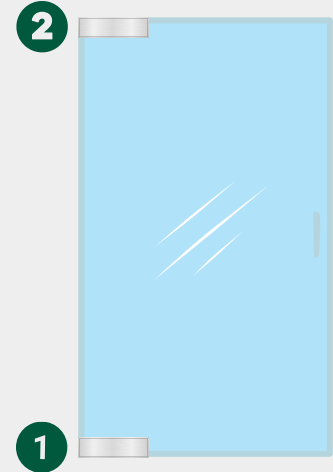

1

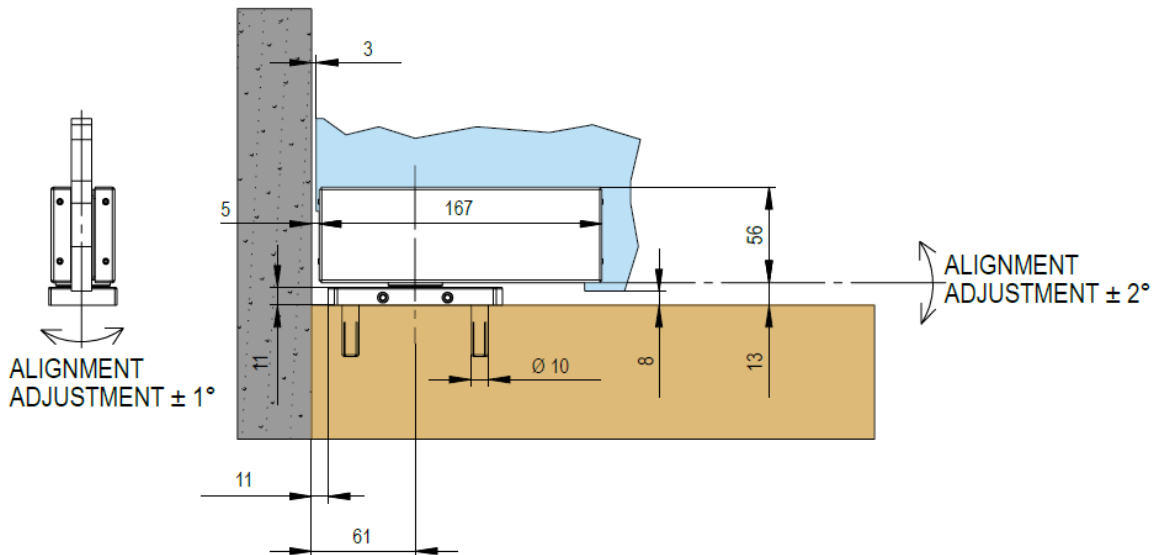
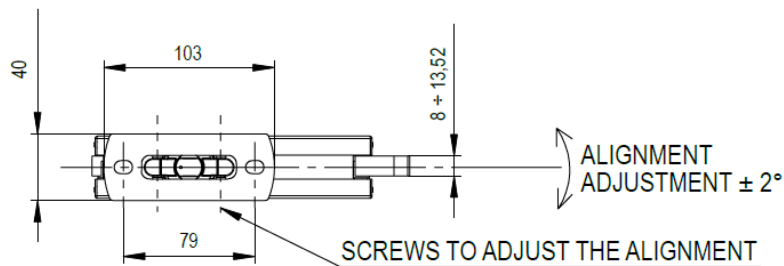



GLASS CUTOUT for Kit #1

1

Glass processing for pivoting applications

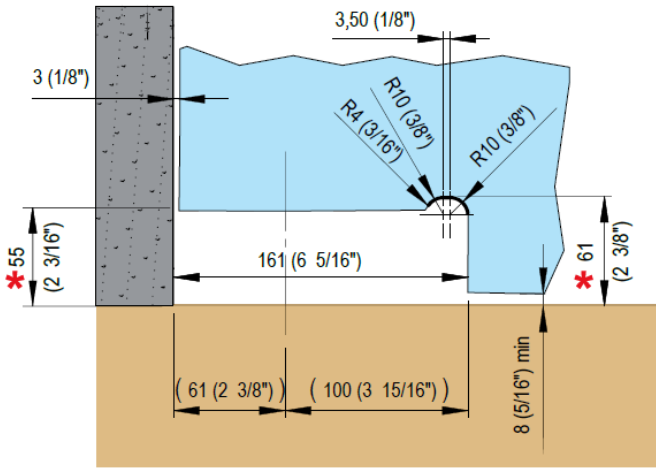

DISTANCE FROM THE FLOOR

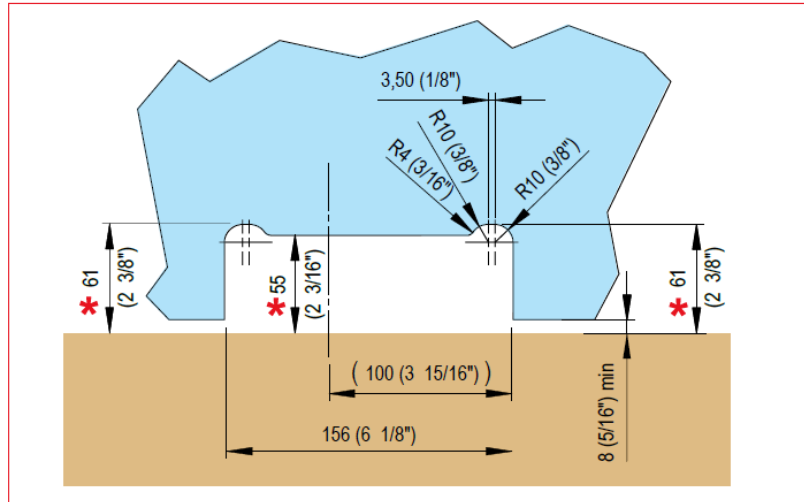

2

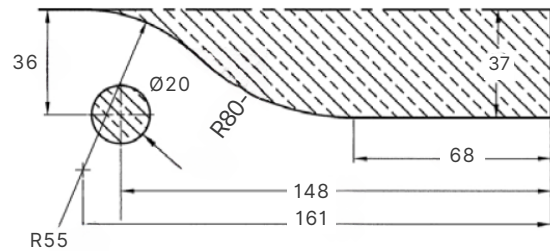
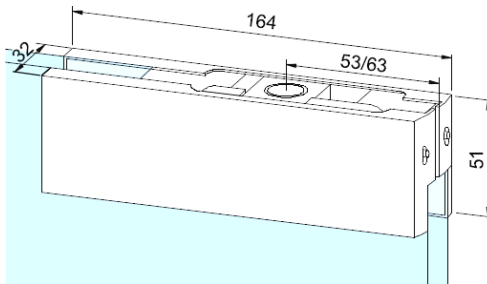

NFK Glazing
& Industrial Supplies

www.nfk.com.au

28 Devlan Street,
Mansfield, QLD 4122

07 3343 3377

sales@nfk.com.au

42 Tacoma Circuit,
Canning Vale, WA 6155

08 9455 3866

wasaless@nfk.com.au



GLASS CUTOUT for Kit #2

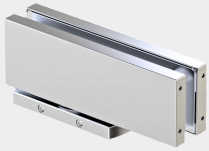

1

Biloba Unica hydraulic door closer



2

Top Corner Patch



3

High-Lite Pivot Patch

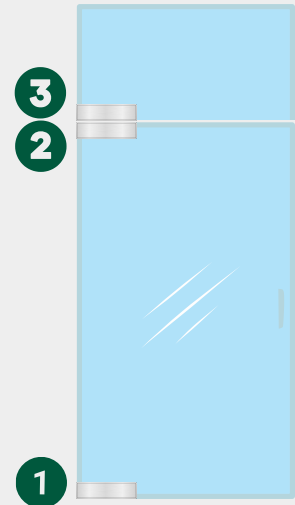

1

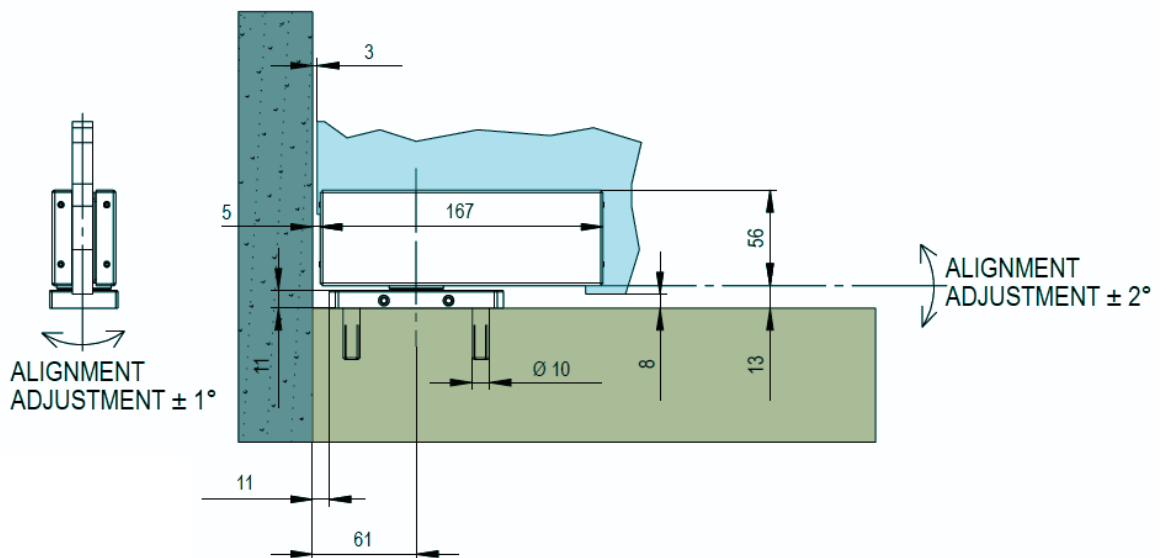
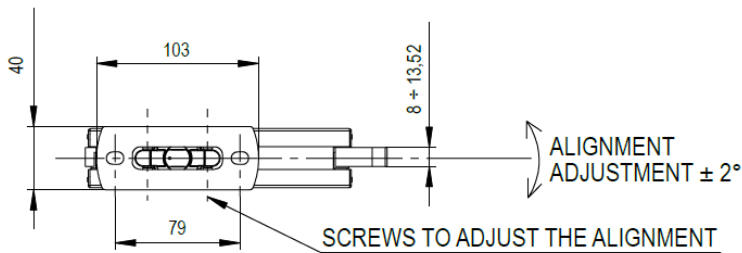



GLASS CUTOUT for Kit #2

1

Glass processing for pivoting applications

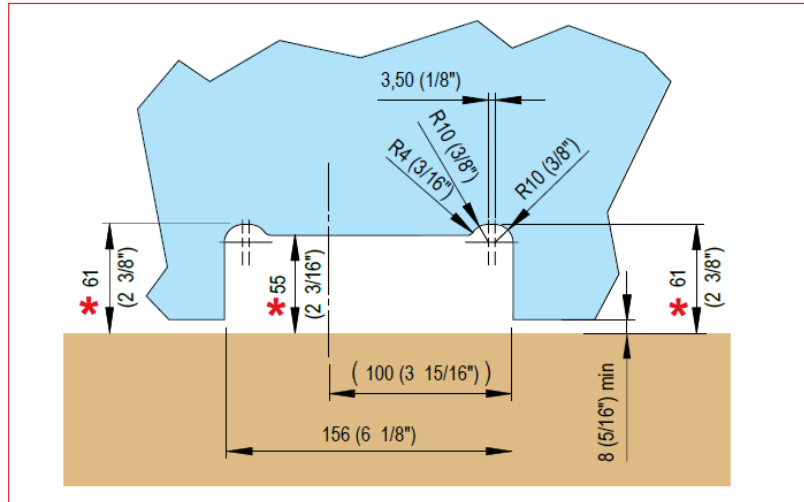
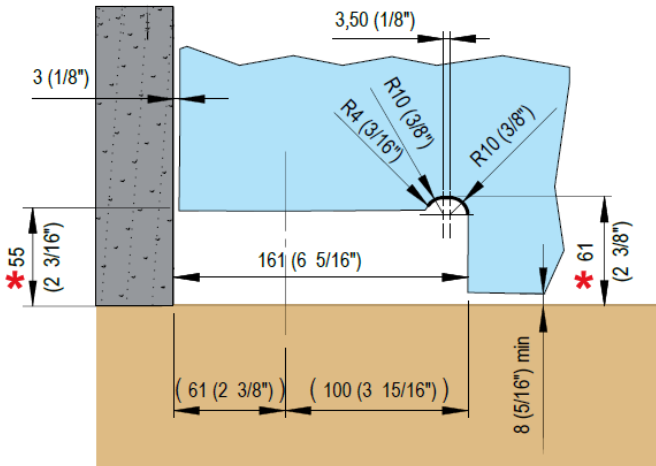

DISTANCE FROM THE FLOOR

2

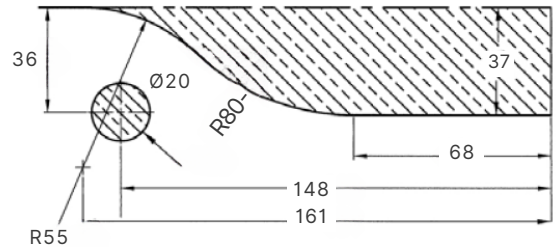
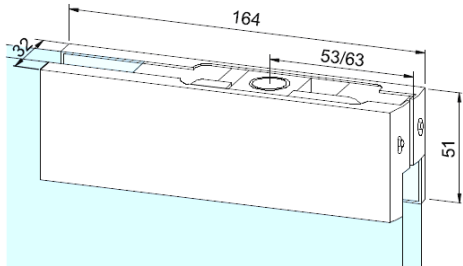

3

A dimensions: 50mm-70mm

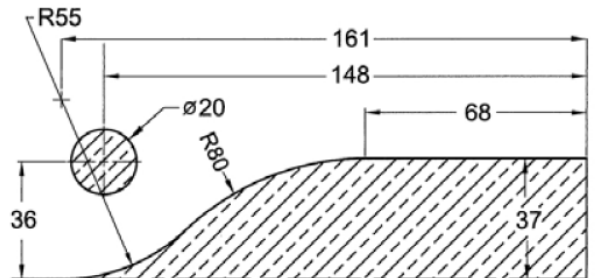
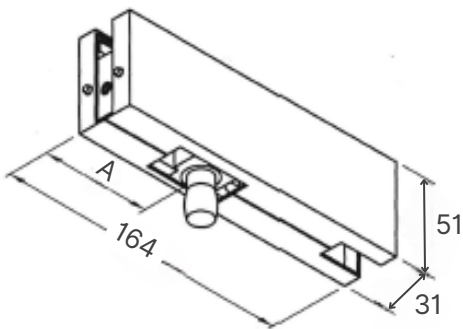

NFK Glazing
& Industrial Supplies

www.nfk.com.au

28 Devlan Street,
Mansfield, QLD 4122

07 3343 3377

sales@nfk.com.au

42 Tacoma Circuit,
Canning Vale, WA 6155

08 9455 3866

wasales@nfk.com.au



GLASS CUTOUT for Kit #3



1

Biloba Unica hydraulic door closer



2

Top Corner Patch



3

Corner link Patch with Pivot

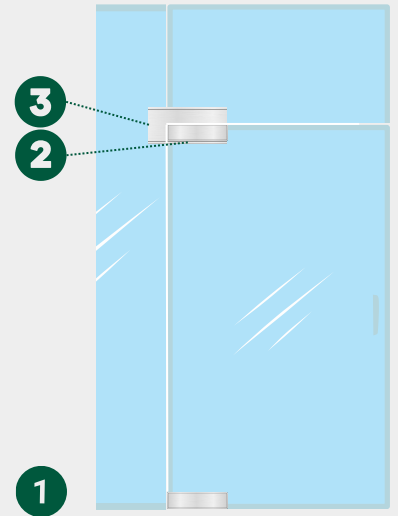

1

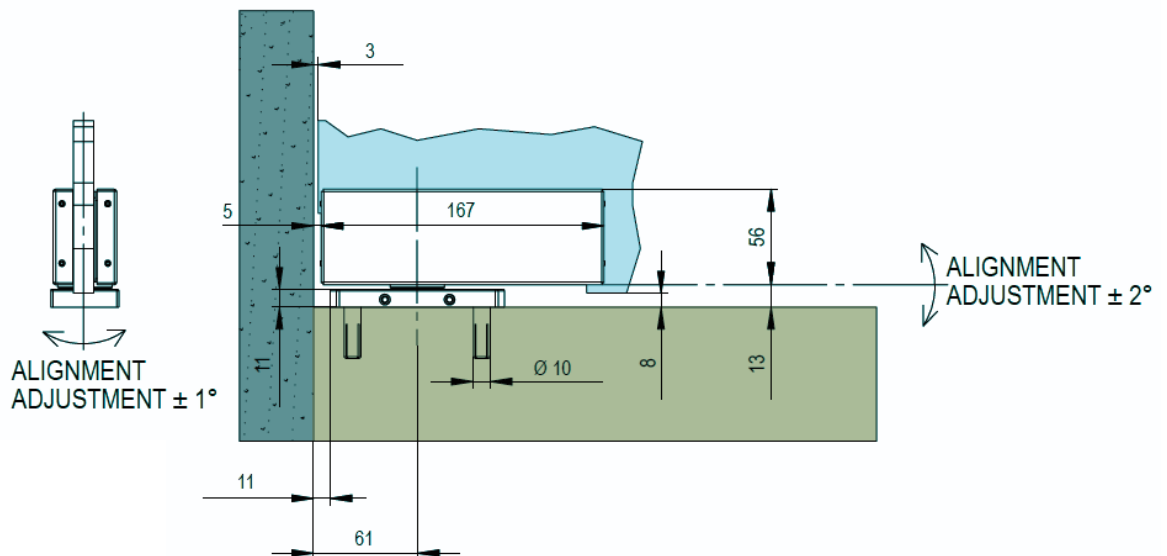
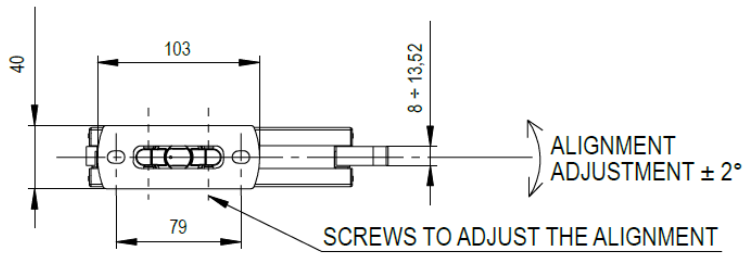

NFK Glazing
& Industrial Supplies

www.nfk.com.au

28 Devlan Street,
Mansfield, QLD 4122

07 3343 3377

sales@nfk.com.au

42 Tacoma Circuit,
Canning Vale, WA 6155

08 9455 3866

wasaless@nfk.com.au



GLASS CUTOUT for Kit #3

Glass processing for pivoting applications

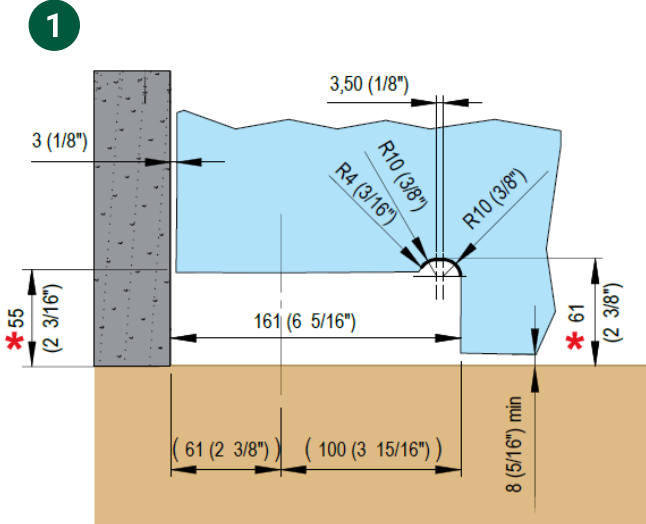

DISTANCE FROM THE FLOOR

