

MIG

Glass Thickness Gauge

MODEL# MG1500
MADE IN THE USA



DESCRIPTION OF PARTS

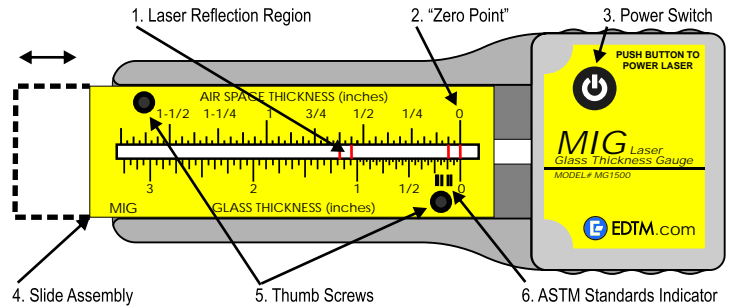

GENERAL DESCRIPTION

The MIG (Manual IG Thickness Gauge) is a durable tool used to measure glass and air space thickness in sealed insulating glass units. Laser reflections off the surfaces of glass are used to determine the thickness of glass, as well as the air space separating the pieces of glass in a sealed IG assembly. The readings are taken from a single side of the IG unit and no additional tools are necessary.

Durable scales are interchangeable on the sliding assembly. The multiple scales are held in place by two black, nylon thumb screws. Due to the scales thin size, the operator can carry numerous scales inside the carrying case and always be prepared for any glass application experienced in the field or factory. The scales are printed in Metric (mm) on one side, and Imperial (inches) on the back side.

The operator can easily measure glass thickness, air space, overall IG thickness, individual panes of glass in a laminated assembly, bullet resistant and triple pane assemblies. The gauge also has been successfully tested for measuring thickness of mirrors and other transparent materials.

The MIG is powered by two standard AAA alkaline batteries (included). Two (2) spare thumb screws are included with each gauge. The black nylon carrying case supplied with the gauge provides a handy method for carriage.

- Laser Reflection Region:** When the laser is energized, the laser beams that reflect off the glass surfaces will appear in this laser reflection region.
- "Zero Point":** The zero point must be aligned with the first laser reflection prior to taking glass thickness readings. All new units are shipped from the factory with the zero point already aligned. If the zero point is out of alignment or if the operator is changing scales, follow the instructions under "Zero Alignment".
- Power Switch:** Prior to energizing the laser, be aware of your surroundings. The laser will exit the gauge from the back side. **DO NOT LOOK DIRECTLY INTO THE LASER BEAM AND NEVER POINT THE LASER BEAM IN THE DIRECTION OF ANOTHER PERSON.** To turn on the laser, simply push and hold down the power button. The laser will activate instantly.
- Slide Assembly:** The slide assembly holds the calibrated scale in place and allows the operator to move the zero point left and right while taking readings. While taking readings, the slide assembly starts in the fully inserted (against the stop) position. After measuring the first lite of glass, the entire slide assembly is slid to the left to measure the air space and subsequent lites of glass.
- Thumb Screws:** The thumb screws are used to align the scale with the zero point as well as to hold the scale in place. The thumb screws also provide a handy method of grasping the slide in order to move it left and right. Two (2) spare thumb screws are included in the carry case.
- ASTM Standards Indicator:** As you become more fluent with the gauge, you will begin to realize the benefits of the ASTM standards indicator. ASTM standards dictate the acceptable tolerances in the various glass thickness ranges. A table is printed on page 3 of this operating manual for your reference. The four lines on the scale represent the thickness ranges of the four most common glass thicknesses used in North America: 3/32"(SS), 1/8"(DS), 3/16", and 1/4". These designations are represented on the scale respectively from right to left, as illustrated below. As you become more fluent in the operation of the gauge, you may be able to overlook the scale graduations and look directly at the ASTM range designations to expedite the measuring process. PLEASE NOTE, the actual glass thickness you measure, can be less than the traditional designations used by the ASTM standard range. For example, notice that traditional 1/4" glass is actually closer to 7/32" in thickness.

ZERO ALIGNMENT

The two thumb screws are used to position the scales correctly on the slide assembly. For ease of use, when the slide is pushed completely in (against the stop), the scales should be positioned so the first reflection (1) will be aligned with the "0" gradient lines. The laser reflections will appear to be slightly wider than the scale lines. Position the scale lines in the center of the laser beam reflection. All scale readings will be made from the center of the laser beam reflections. Be sure to inspect the top surface of the slide assembly to make sure it is free of dirt and debris.

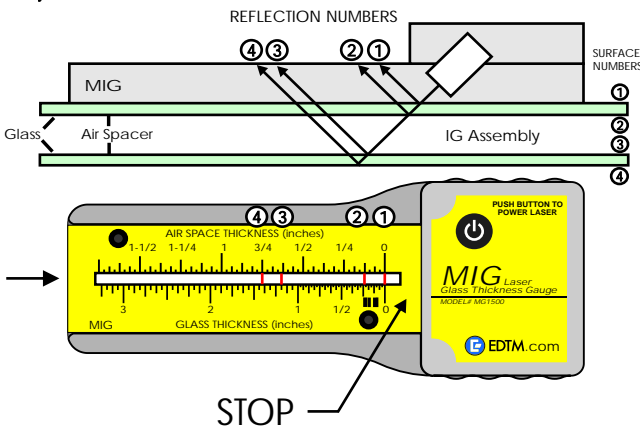

To align the scale, push the slide assembly completely in (against the stop). Place the gauge on a piece of flat glass and push the power button. Loosen both thumb screws and position the scale so the center of the first laser reflection (1) aligns with the "0" gradient. DO NOT move the entire slide assembly, only the scale itself. Once you have positioned the scale to your satisfaction, tighten the thumb screw in the lower right corner. After tightening this screw, verify that the zero point is still aligned. If not, readjust the scale. Before tightening the screw in the upper left corner, verify the laser reflections are centered on the viewing area. Also, before tightening the upper left screw, apply pressure on the center of the scale. This will verify that the scale is resting flatly against the slide assembly.

Each time you switch to a new scale, it will be necessary to realign the "zero point". The additional scales for the gauge are included in the carry case.

ASTM Standards Indicator:

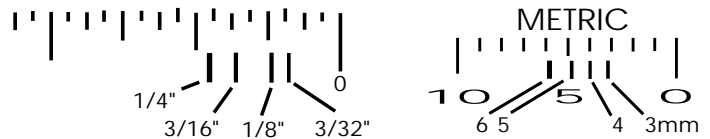

GLASS THICKNESS & AIR SPACE MEASUREMENT: IG UNITS

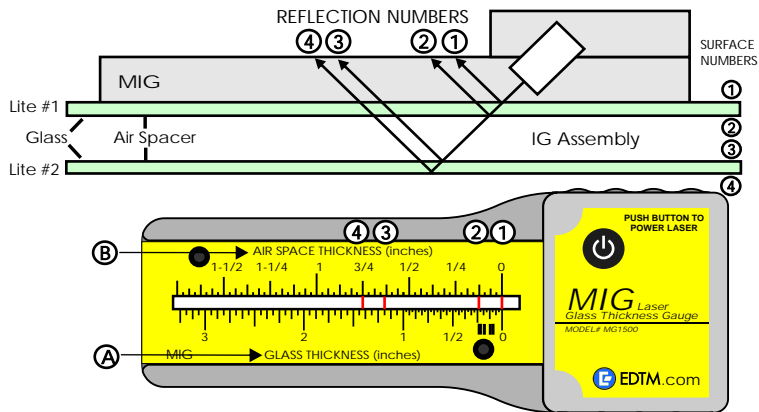

GLASS THICKNESS MEASUREMENT (LITE #1)

The bottom scale (Reference point "A") is used for measuring the glass thickness while the top scale (Reference point "B") is used for measuring the air space. Please note that the scales are different. DO NOT attempt to use the wrong scale for your measurement. The best method of measurement is to work your way through the IG assembly. In other words, measure the thickness of lite #1 first, then read the air space, and finally read the thickness of lite #2. To begin, verify that reflection 1 is aligned with your "zero point". Reflection 1 represents the top surface of the first piece of glass, while reflection 2 represents the bottom of the first piece of glass. Once the zero point is aligned, you can take your measurement. The distance between reflection 1 and 2 is the thickness of the first lite of glass, as measured on the GLASS THICKNESS scale. The example shows a glass thickness of approximately 7/32". Regarding the ASTM standards indicator, please note this falls into the acceptable range for 1/4" glass thickness.

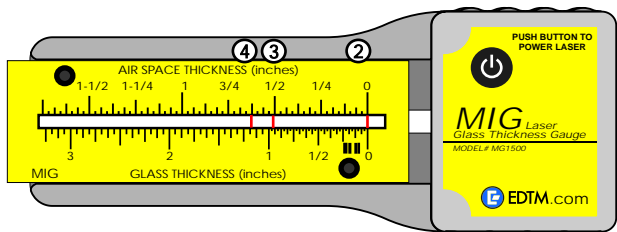

AIR SPACE MEASUREMENT

To measure the air space, slide the entire slide assembly scale to the left and align reflection 2 with the zero point. Once aligned, you can now measure the air space thickness using the top scale. Reflection 3 represents the top surface of the second lite of glass. The distance between reflection 2 and 3 represents the air space, as indicated on the AIR SPACE THICKNESS scale. The example shows an air space of approximately 1/2 inch.

WARNING!

For the most accurate measurement of air space thickness, the operator should take readings near the edge of the IG assembly. Be aware that many IG units may sag inward or bow outward due to air pressure differences inside the window as opposed to the outside atmospheric pressure. If a window deflects inward or outward, the air space thickness in the center of the IG unit will differ from the thickness near the edge. The least amount of deflection will occur near the edges of the glass near the spacer bar. Please note, this is also a great method to check IG units for deflection in production as well as in the field.

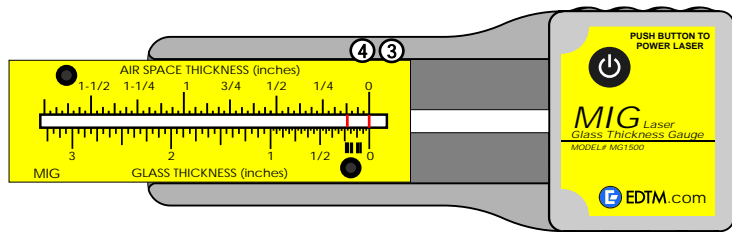

GLASS THICKNESS MEASUREMENT (LITE #2)

To measure the glass thickness of the second lite of glass, slide the entire slide assembly to the left again, so that the "zero point" is lined up with reflection 3. Reflection 4 represents the bottom surface of the second lite of glass. The distance between reflection 3 and 4 is the glass thickness of the second lite of glass. Be sure to use the "GLASS THICKNESS" scale when measuring glass thickness.

OVERALL IG UNIT THICKNESS MEASUREMENT

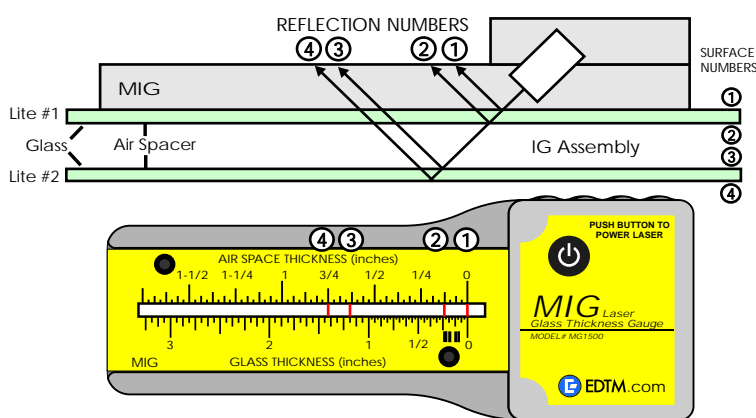

To use the Overall IG Unit Thickness scales, the operator must first verify the glass thickness that is in the IG unit. To test this, the operator may use the glass and air space thickness scale, or use the ASTM standards indicator which is located on both the top and bottom of the Overall IG Unit Thickness scales. To use this, simply align the zero point as described previously. Using the ASTM indicators, measure the thickness of both lites of glass in the IG assembly. To use the overall thickness scales, both lites of glass must be in the same thickness designation. In other words, if you have an IG assembly with a 3/16" pane for lite 1 and a 1/4" pane for lite 2, you CAN NOT use this scale. Both lites must be the same thickness.

To measure the overall IG unit thickness, align the zero point. Verify that the glass thickness of the IG unit matches the scale you have installed on the gauge slide. Using the correct thickness scale, measure the distance between reflection 1 and reflection 4. This is the overall IG unit thickness for the assembly being tested.

The example above illustrates an IG unit constructed of 1/4" lites of glass. The overall thickness of the IG unit is 31/32", as measured on the OVERALL IG UNIT THICKNESS scale for 1/4" glass.

APPLICATIONS

This gauge has been successfully tested on a variety of glass combinations. The following list includes the various types of glass that have been tested successfully: Single pane float glass, IG units (double, triple & quadruple glaze++), clear, Low-E, tempered, reflective, bronzed, tinted, laminated, bullet-proof, mirrors, plus others. The following explanations define the most common applications.

Single Pane Float Glass & IG Units

See "Glass Thickness & Air Space Measurement: IG units".

Triple Glazed IG Units

Triple glazed IG units are measured in the same manner as the double glazed IG units. The only difference will be two extra laser reflections. These two extra reflections represent the third lite of glass. The distance between reflection 4 and 5 is the second air space (between lite 2 and lite 3), as measured on the Air Space Scale. The distance between reflection 5 and 6 corresponds to the glass thickness of lite 3. Be sure to use the Glass Thickness scale for this measurement.

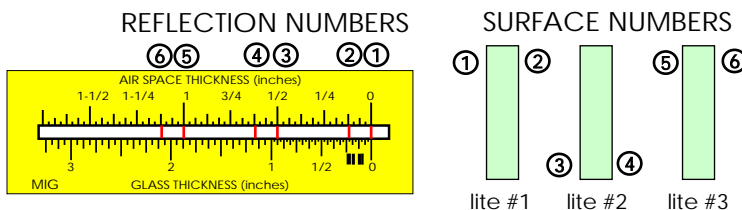

Laminated Glass & Bullet Resistant Glass

Bullet resistant and laminated glass are measured in like manners. Use only the Glass Thickness scale for these measurements. A faint laser reflection will occur at each laminate substrate. This allows you to measure the thickness of each piece of glass in the laminated assembly, as well as the overall thickness of the laminated assembly. The distance between reflection 1 and 2 is the thickness of pane 1. The distance between 2 and 3 is the thickness of pane 2. The distance between 3 and 4 represents the thickness of pane 3. The distance between reflection 1 and 4 will yield the overall thickness of the laminated assembly. All of these measurements use the Glass Thickness Scale. The illustration shows two pieces of 1/4" glass laminated on both sides of a 1/2" piece of glass. The overall thickness of the laminated assembly is 1". If the regular scale does not show the laminate inner-layers, you can switch to the scale labeled "FOR LAMINATED OR BRIGHT

SUNLIGHT". This scale is helpful for viewing the faint laminate inner-layer reflections. When using this scale, you will need to tilt your head at a 45 degree angle to view the reflections.

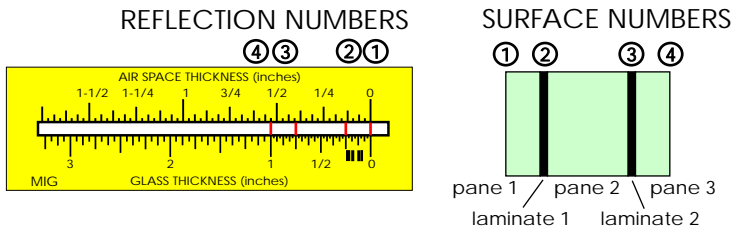

Mirrors and Reflective Glass

This gauge is capable of measuring mirror thickness as well as standard reflective glass used in the window industry. It is recommended that the user test the gauge on various reflective surfaces prior to use in the field. This will help the user to better understand the capabilities of the product.

For mirrors and single panes of reflective glass, it is recommended that the user take readings from the reflective side of the glass. Readings from the non-reflective side will cause additional stray reflections to occur, that may appear confusing. Readings from the reflective side will reduce the stray reflections and allow for easier glass thickness measurement. Due to the intensity of the laser reflection off the reflective surface (surface 1), the second reflection (surface 2) will appear weaker than normal.

For insulating units containing reflective glass, again it is recommended to take measurements from the reflective side of the IG unit. In other words, place the gauge on the lite of glass that has the reflective coating. It is possible to take readings on the side of the IG unit containing the non-reflective lite of glass, however additional stray reflections may occur. Again, it is important that the user test various reflective surfaces to achieve a better understanding of the laser reflections.

OPERATING CONDITIONS

FLATNESS: Prior to every reading, verify the gauge is resting flatly against the glass surface. Do not tilt the gauge or place any items under the gauge when taking readings. Tilting the gauge in any way will adversely affect the accuracy of the readings.

BRIGHT LIGHT ENVIRONMENTS: This gauge will allow the operator to take measurements in nearly all light conditions. If the operator is working in extreme bright light, cupping your hand over the scale can help improve the contrast of the laser on the scale. If shadowing the scale area does not work well enough, there is a scale that is designed specifically for bright light situations. Apply the scale that is labeled "FOR LAMINATED OR BRIGHT SUNLIGHT". With this scale in place, it will be necessary to view the laser reflections in the same plane as the reflections. In other words, move your head to view the reflections at a 45 degree angle, as shown in the following illustration. The laser reflections should appear brighter with this scale.

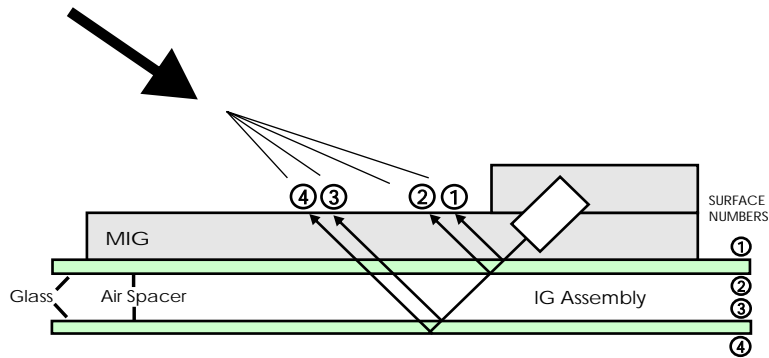

SAFETY PRECAUTIONS AND MAINTENANCE

When not in use, the MIG and all scales should be kept in the carrying case for protection.

It is imperative that the bottom surface of the gauge is kept clean and free of any debris. Any build-up on the bottom surface can cause the gauge to rock and/or not sit flat against the glass, causing incorrect readings. Therefore routinely inspect and clean the bottom surface of the gauge.



This product emits a laser beam from the back side. DO NOT point the laser at any ones eyes. ALWAYS check the other side of the window being tested to ensure that no one will be looking directly into the laser.

On reflective glass and mirrors, be aware that a significant portion of the laser intensity is reflected back in the direction of the sliding scale. If the slide assembly is pulled out significantly, the scale and slide assembly will no longer block the reflection of the laser off the first (reflective) surface.

The MIG is powered by 2 AAA alkaline batteries. If the laser stops operating, replace the batteries with alkalines. To access the batteries, remove the four screws located on the top surface of the gauge. Do not touch the laser or any other items found inside the cover. Replace the batteries and refasten the cover. Be sure to install the batteries correctly (polarity +/-). Installing the batteries backwards may cause permanent damage to the laser and will not be covered by the product warranty.

AMERICAN SOCIETY FOR TESTING AND MATERIALS (ASTM) Tolerance specifications for flat glass						
TRADITIONAL DESIGNATION	DESIGNATION		TOLERANCE			
	mm	inches	mm min.	mm max.	inches min.	inches max.
3/32 in. (single)	2.5	0.09	2.16	2.57	0.085	0.101
1/8 in. (double)	3.0	0.12	2.92	3.40	0.115	0.134
5/32 in.	4.0	0.16	3.78	4.19	0.149	0.165
3/16 in.	5.0	0.19	4.57	5.05	0.180	0.199
7/32 in.	5.5	0.21	5.08	5.54	0.200	0.218
1/4 in.	6.0	0.23	5.56	6.20	0.219	0.244
5/16 in.	8.0	0.32	7.42	8.43	0.292	0.332
3/8 in.	10.0	0.39	9.02	10.31	0.355	0.406

WARRANTY
The manufacturer warrants all models of the MG1500 to be free from defects in material and workmanship under normal use and service as specified within the operator's manual. The manufacturer shall repair or replace the unit within one (1) year from the original date of shipment after the unit is returned to the manufacturer's factory, prepaid by the user, and the unit is disclosed to the manufacturer's satisfaction, to be thus defective. This warranty shall not apply to any unit that has been repaired or altered other than by the manufacturer. The aforementioned provisions do not extend the original warranty period of the unit which has been repaired or replaced by the manufacturer. Batteries are not covered by warranty.

The manufacturer assumes no liability for the consequential damages of any kind through the use or misuse of the MG1500 product by the purchaser or others. No other obligations or liabilities are expressed or implied. All damage or liability claims will be limited to an amount equal to the sale price of the MG1500, as established by the manufacturer.