



NFK GLAZING & INDUSTRIAL SUPPLIES

Professional Products for the Glass & Glazing industry

THE INVISIBLE PROTECTION

SABCO ORIGINAL

FRAMELESS BALUSTRADE SYSTEM

PERFORMANCE FROM 3 TO 5 KN
FLOOR MOUNTING | BUILT-IN MOUNTING



NFK Glazing
& Industrial Supplies

www.nfk.com.au

 28 Devlan Street,
Mansfield, QLD 4122

 07 3343 3377

 sales@nfk.com.au

 42 Tacoma Circuit,
Canning Vale, WA 6155

 08 9455 3866

 wasales@nfk.com.au

SABCO ORIGINAL CHANNEL BALUSTRADE SYSTEM



- Designed and engineered in France
- Suitable for surface mounting / built-in mounting/ lateral mounting
- The system is very flexible and can be adapted to various installation conditions using different components
- Minimum installation time and effort
- One-side wedges offer the option to install glass and tighten the clamp from one side only
- Numerous glass types tested in AU
- Adjustment of the glass alignment: + or - 15mm at 1.10m
- Mounting with cladding is highly recommended

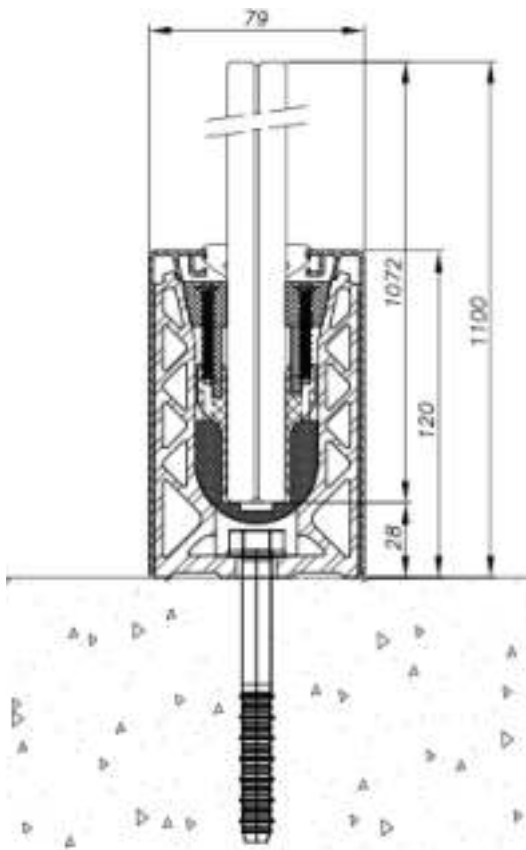

Suitable for glass thickness

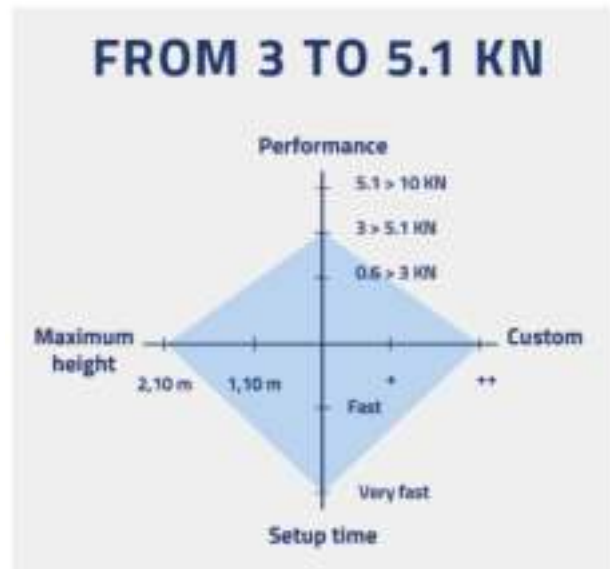

NFK Glazing
& Industrial Supplies

www.nfk.com.au

28 Devlan Street,
Mansfield, QLD 4122

07 3343 3377

sales@nfk.com.au

42 Tacoma Circuit,
Canning Vale, WA 6155

08 9455 3866

wasaless@nfk.com.au

www.nfk.com.au

EASY INSTALLATION TO FIT

Sabco channel system differs from other products on the market by being easy and fast to assemble!

The simple installation makes it ideal for installing on stairs and ramps without special tools or messy cement grouts.

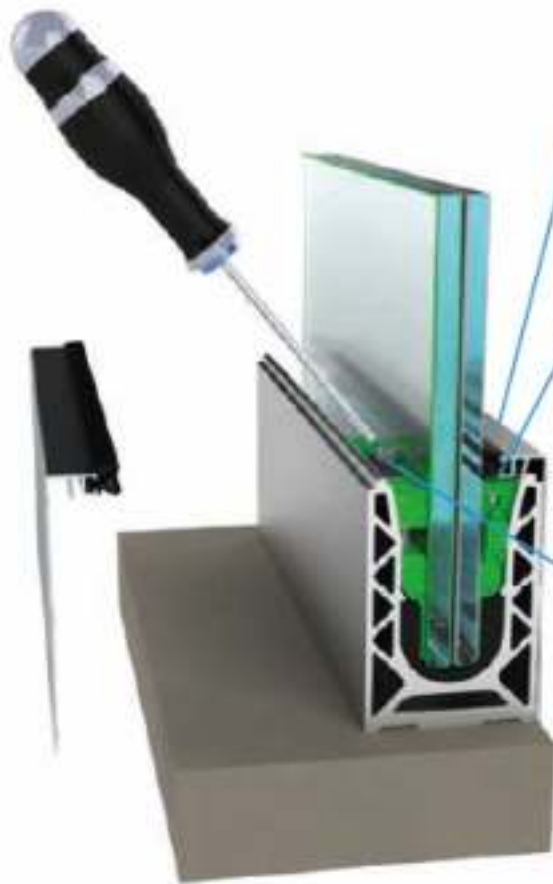

1

CLADDING WITH SEAL

2

GLASS ADJUSTMENT



SABCO's wedge system aligns the glass for a quicker and easier installation.

*Profile fixing suitable every 400 mm**

3

「SIDE」

ONE SIDE ONE STEP !

Easy adjustment thanks to the clamps, no other installation requirements except tightening!

NFK Glazing
& Industrial Supplies

www.nfk.com.au

📍 28 Devlan Street,
Mansfield, QLD 4122

☎ 07 3343 3377

✉ sales@nfk.com.au

📍 42 Tacoma Circuit,
Canning Vale, WA 6155

☎ 08 9455 3866

✉ wasaless@nfk.com.au

SABCO ORIGINAL CHANNEL BALUSTRADE SYSTEM KIT

The Kit is formed individually depending on the glass thickness and length, and installation conditions.

① RAIL

Anodised finish

Original has anodised finish on the rail.

③ WEDGE

Very fast installation

Simple adjustment thanks to the patented clamps, no other actions except tightening.

④ SEALS

Protection

For a better protection against dust and water.

② CLADDING

Choose your cladding!

There is a wide range of cladding options for different project specifications.

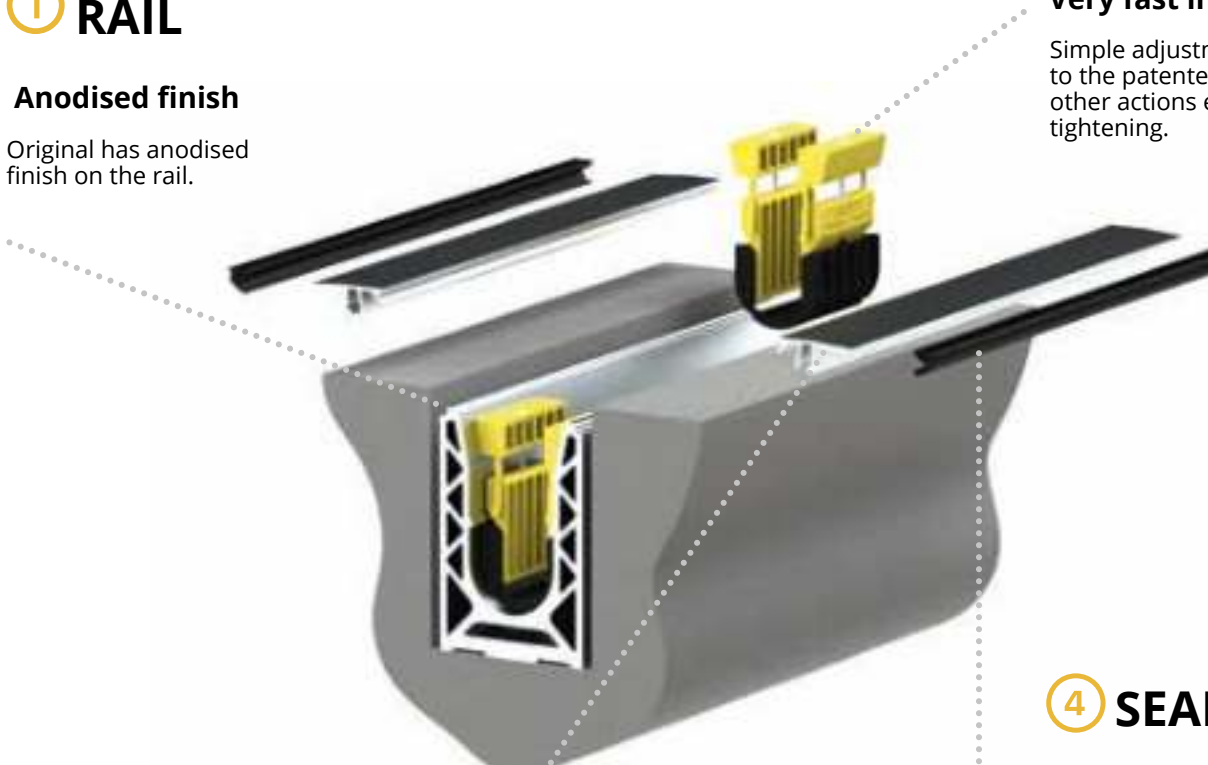

NFK Glazing
& Industrial Supplies

www.nfk.com.au

📍 28 Devlan Street,
Mansfield, QLD 4122

☎ 07 3343 3377

✉ sales@nfk.com.au

📍 42 Tacoma Circuit,
Canning Vale, WA 6155

☎ 08 9455 3866

✉ wasales@nfk.com.au

1 RAIL (PROFILE)

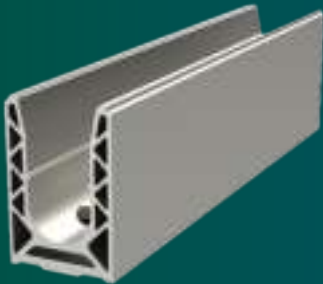

- | | | |
|---|---|---------------|
| 1 | Sabco Original Rail, Floor/Built-In Mounting, 5000 mm | 87-0070R20.11 |
| 2 | Sabco Original Rail, Floor/Built-In Mounting, 2500 mm | 87-0070R10.11 |

Technical characteristics

Length: 2 500 mm / 5 000 mm

Type: Drilled every 200mm

Width: 75 mm

Height of profile: 112 mm

Material Aluminum

Height of guardrail: Standard: 1 100 mm

Fixing the profile Every 200 to 400 mm depending on the requirements of your project.

Glass thickness: 12-25.52mm

Finish: Anodised

Suitable for: Residential and Public Application

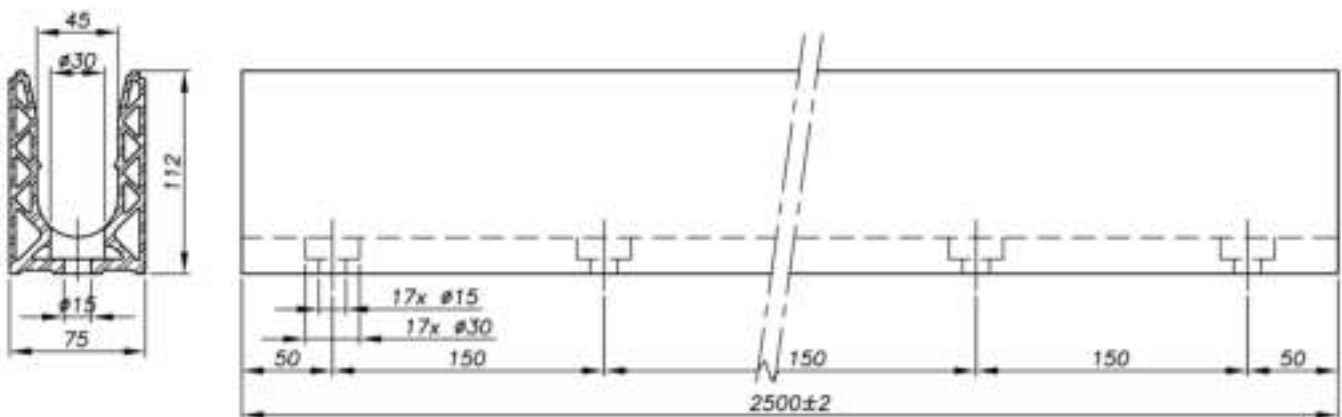

GUARDRAIL INCLINE

Up to 40° angle to the horizontal.
The mounting is identical to the
horizontal installation process.

Product code: 87-0070R11.11

NFK Glazing
& Industrial Supplies

www.nfk.com.au

 28 Devlan Street,
Mansfield, QLD 4122

 07 3343 3377

 sales@nfk.com.au

 42 Tacoma Circuit,
Canning Vale, WA 6155

 08 9455 3866

 wasales@nfk.com.au

2

ONE-SIDE | DOUBLE-SIDED WEDGES

- Reduction of installation time: SABCO wedges solution, allowing glass adjustment, 1 meter: + or - 15mm adjustment
- Durability: tested and validated in a test laboratory during ageing tests
- Safety screws: special anti-corrosion treatment (mechanical and corrosion resistance 2x better than stainless steel screws)
- 100% recycled and recyclable
- Material: ABS
- Compatible with different glass thicknesses

Double-sided fastening



- Fastening on both sides of the profile
- 1 box of 10 wedges for a 2.5m profile

One-sided fastening



- Fastening on one side of the profile
- 8 wedges for a 2.5m profile
- Perfect for balcony balustrade higher than 2nd floor

#	GLASS THICKNESS	11.7-13.3MM	12.4-13.2MM	14.5-15.5MM	16.2-18.2MM	16.8-17.5MM	18-20.3MM	20.4-22.2MM	20,8-21,5MM	24.2-25.9MM
1	Double-side wedge	87-0070CALE12	X	87-0070CALE15	87-0070CALE08	X	87-0070CALE19	87-0070CALE10	X	87-0070CALE26
2	One-side 2.0 wedge	X	87-0070CALE1S06	X	X	87-0070CALE1S08	X	X	87-0070CALE1S10	X

NFK Glazing & Industrial Supplies

www.nfk.com.au

28 Devlan Street, Mansfield, QLD 4122

07 3343 3377

sales@nfk.com.au

42 Tacoma Circuit, Canning Vale, WA 6155

08 9455 3866

wasales@nfk.com.au

3

SIDE & HORIZONTAL CLADDINGS

THE DETAIL THAT MAKES THE DIFFERENCE



- For floor mounting
- There is a wide range of cladding options for different project specifications and requirements to make your application look perfect
- The cladding range is compatible with one-sided or double-sided wedges utilizing the two different seals
- Available in length 2.5 and 5 metres
- Material: aluminium
- Finish: anodised aluminium

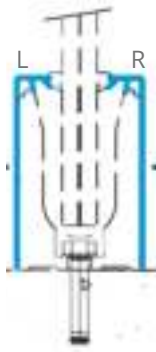

Configuration A



Configuration B



Configuration C

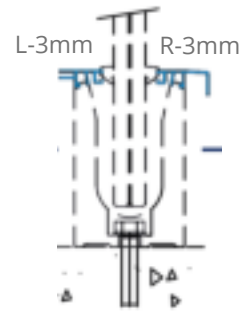

Configuration E - 3mm

Cladding thickness options: 3mm (L, R), 10mm (R), 15mm (R), 20mm (R) - available upon request

#	Length	2500MM			5000MM		
		Configuration	A	B	C	A	B
1	Left Cladding	87-0070C209.11	87-0070C210.11	87-0070C204.11	87-0070C509.11	87-0070C510.11	87-0070C504.11
2	Right Cladding	87-0070C209.11	87-0070C209.11	87-0070C209.11	87-0070C509.11	87-0070C509.11	87-0070C509.11
3	Cladding G12&19, Left	87-0070C205.11	87-0070C206.11	X	87-0070C505.11	87-0070C506.11	X
4	Cladding G12&19, Right	87-0070C205.11	87-0070C205.11	87-0070C205.11	87-0070C05.11	87-0070C505.11	87-0070C505.11
5	Cladding, Mix Seal, Left	87-0070C209.11	X	X	87-0070C509.11	X	X
6	Cladding, Mix Seal, Right	87-0070C209.11	87-0070C209.11	87-0070C209.11	87-0070C509.11	87-0070C509.11	87-0070C509.11
7	Cladding with slab edge	X	87-0070C210.11	X	X	87-0070C510.11	X
8	High cladding slab edge mix seal, Left	X	87-0070C210.11	X	X	87-0070C510.11	X

NFK Glazing
& Industrial Supplies

www.nfk.com.au

28 Devlan Street,
Mansfield, QLD 4122

07 3343 3377

sales@nfk.com.au

42 Tacoma Circuit,
Canning Vale, WA 6155

08 9455 3866

wasales@nfk.com.au

3 UPPER COVER CLADDINGS

THE DETAIL THAT MAKES THE DIFFERENCE



- Suitable for built-in mounting
- There is a wide range of cladding options for different project specifications and requirements to make your application look perfect
- The cladding range is compatible with one-sided or double-sided wedges utilizing the two different seals
- Available in length 2.5 and 5 metres
- Material: aluminium
- Finish: anodised aluminium



Configuration A

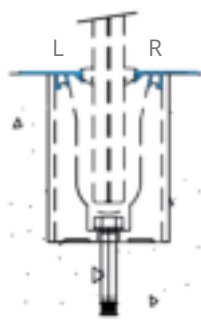

Configuration B

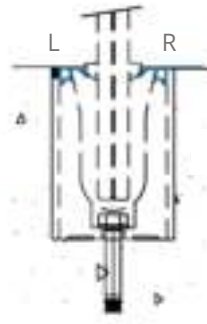

Configuration C

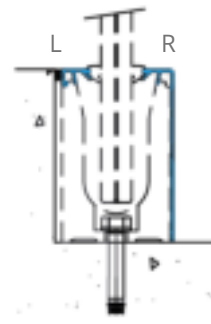

Configuration D

#	Configuration	2500MM				5000MM			
		A	B	C	D	A	B	C	D
1	Left Cladding	87-0070C217.11	87-0070C204.11	87-0070C217.11	87-0070C217.11	87-0070C517.11	87-0070C504.11	87-0070C517.11	87-0070C517.11
2	Right Cladding	87-0070C217.11	87-0070C204.11	87-0070C204.11	87-0070C209.11	87-0070C517.11	87-0070C504.11	87-0070C504.11	87-0070C509.11
3	Cladding G12&19, Left	87-0070C206.11	X	87-0070C206.11	87-0070C206.11	87-0070C506.11	X	87-0070C506.11	87-0070C506.11
4	Cladding G12&19, Right	87-0070C206.11	X	X	87-0070C205.11	87-0070C506.11	X	X	87-0070C505.11
5	Cladding, Mix Seal, Left	87-0070C217.11	X	87-0070C217.11	87-0070C217.11	87-0070C517.11	X	87-0070C517.11	87-0070C517.11
6	Cladding, Mix Seal, Right	87-0070C217.11	X	X	87-0070C209.11	87-0070C517.11	X	X	87-0070C509.11

NFK Glazing
& Industrial Supplies

www.nfk.com.au

28 Devlan Street,
Mansfield, QLD 4122

07 3343 3377

sales@nfk.com.au

42 Tacoma Circuit,
Canning Vale, WA 6155

08 9455 3866

wasales@nfk.com.au

4 RUBBER SEALS



- Protect the inside of the profile from dust and water
- The seal should be installed after the glass
- Compatible with all extrusions
- High UV and hydrocarbon resistance
- Material: EPDM
- Sold by the metre
- Colour: black
- Suitable for a variety of glass thicknesses

Press-in gaskets, DOUBLE-SIDED



Snap-fit gaskets, ONE-SIDED

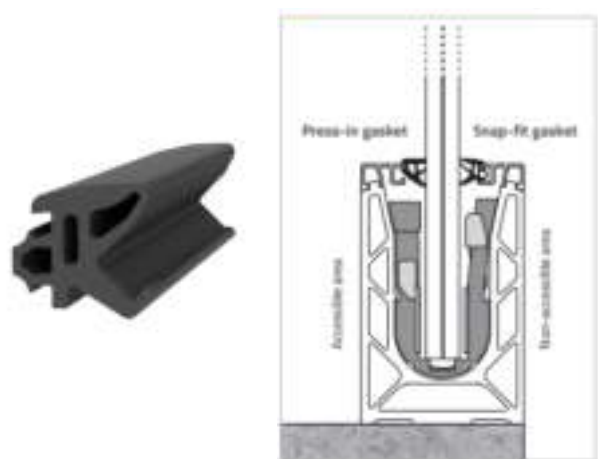

#	GLASS THICKNESS	12 -> 12,76 MM	15 MM	16,76 -> 17,52 MM	20,76 -> 21,52 MM	24,2 -> 25,9 MM	24,76 -> 25,5 MM
1	Press-in gaskets, Double-Sided	87-0070J9/16	87-0070J9/16	87-0070J0808	87-0070J1010	X	87-0070J1212
2	Snap-fit gaskets, One-Sided	X	X	87-0070J0808C	87-0070J1010C	87-0070J1212C	X

NFK Glazing
& Industrial Supplies

www.nfk.com.au

28 Devlan Street,
Mansfield, QLD 4122

07 3343 3377

sales@nfk.com.au

42 Tacoma Circuit,
Canning Vale, WA 6155

08 9455 3866

wasaless@nfk.com.au

4

END CAPS



- End caps designed to close the ends of profiles
- Adhesive tape mounting

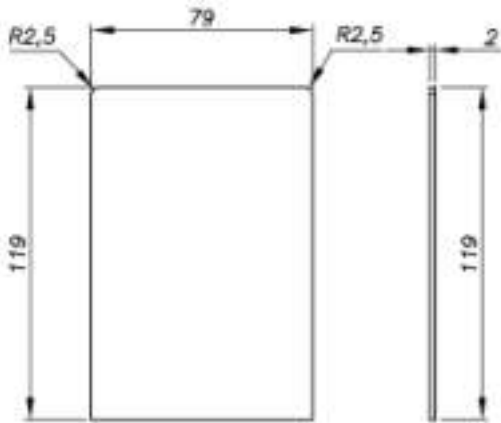

END CAPS

-
- | | | |
|---|--|--------------|
| 1 | End cap suitable for Sabco EVO/Original rail,
Anodised Aluminium finish | 87-0070CE.11 |
|---|--|--------------|
-

CREATE YOUR OWN SOLUTION

You'll get a tailored solution to meet your specific requirements using different accessories: cladding, wedges, seals etc.



TYPICAL KIT COMPONENTS

for 5m length balustrade, 15mm glass thickness

#	COMPONENT	QTY
1	Sabco Original Rail, 5m	1
2	One-sided wedges for 15mm glass	16 (1 box)
3	Side and horizontal cladding (Configuration C), 5m	2
4	Rubber seals, Press-in gaskets (double-sided)	5m
	Snap-fit gaskets (one-Sided)	5m
5	Spacers	2
6	End cap	1
7	Screws	box
8	Alignment pins	box

NFK Glazing
& Industrial Supplies

www.nfk.com.au

28 Devlan Street,
Mansfield, QLD 4122

07 3343 3377

sales@nfk.com.au

42 Tacoma Circuit,
Canning Vale, WA 6155

08 9455 3866

wasales@nfk.com.au

- Sabco Original Balustrade system is suitable for public & commercial application
- In comparison with the other channel balustrade systems Sabco is the easiest and fastest in installation
- Guardrail incline angle can be up to 40° to the horizontal
- The rail is suitable for curving
- A big range of components makes the system look perfect with most of the glass thickness at a variety of installation conditions

NFK Glazing
& Industrial Supplies

www.nfk.com.au

 28 Devlan Street,
Mansfield, QLD 4122

 07 3343 3377

 sales@nfk.com.au

 42 Tacoma Circuit,
Canning Vale, WA 6155

 08 9455 3866

 wasales@nfk.com.au